

Article number: 20166V202SW

Description: Off-set baseplate clamps GN166-V20-2-SW  
GN166

## Measures

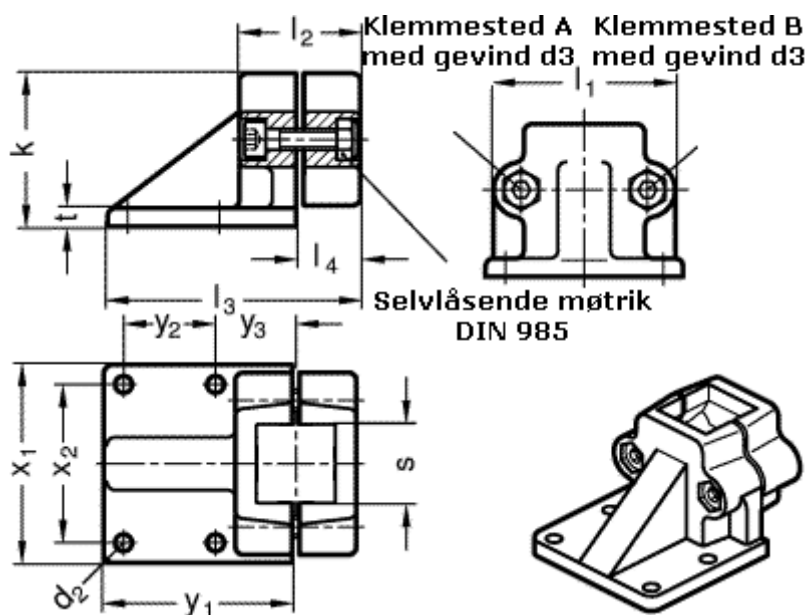

d2 = 7	t = 7
d3 = M 8	x1 = 75
k = 58	x2 = 60
l1 = 69	y1 = 72
l2 = 46	y2 = 35
l3 = 96	y3 = 30
l4 = 23	
S = V20	